

# DAYAMON POOL

# Escalera

Pedido

Presupuesto

## EMISOR

Fecha : .....

Ref. Cliente : .....

### ESCALERA CORNER 3 PELDAÑOS

#### Opción

Anti-Deslizante Azul Claro	<input type="checkbox"/>
Anti-Deslizante Arena	<input type="checkbox"/>

#### Posición de la Escalera

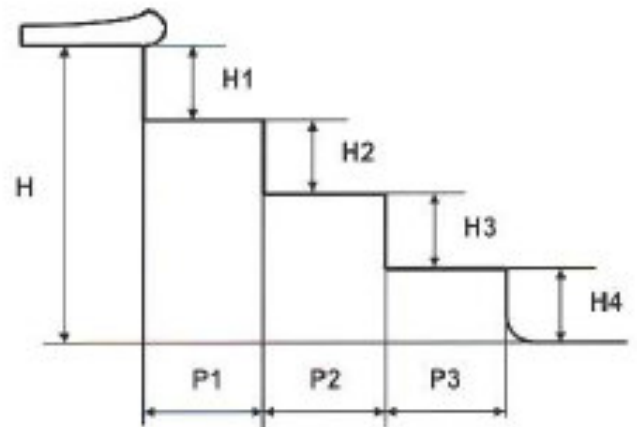
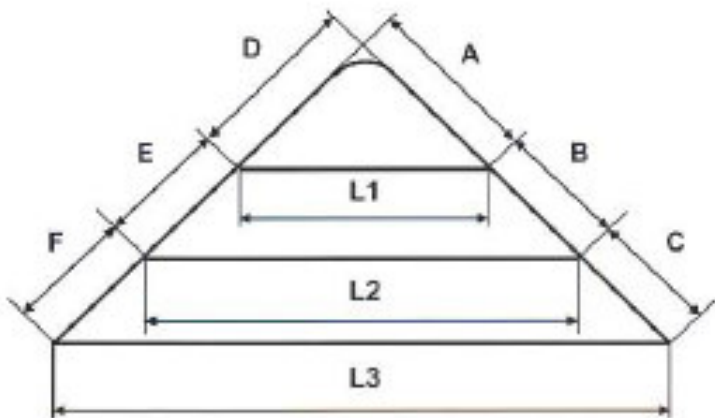

L1	L2	L3

H	H1	H2	H3	H4

Verificar que  $H1 + H2 + H3 + H4 = H$

P1	P2	P3

A	B	C	D	E	F

# DAYAMON POOL

# Escalera

Pedido

Presupuesto

**EMISOR**

Fecha : .....

Ref. Cliente : .....

## ESCALERA CORNER CIRCULAR

### Opción

Anti-Deslizante Azul Claro	<input type="checkbox"/>
Anti-Deslizante Arena	<input type="checkbox"/>

### Posición de la Escalera

Baño Pequeño

Baño Grande

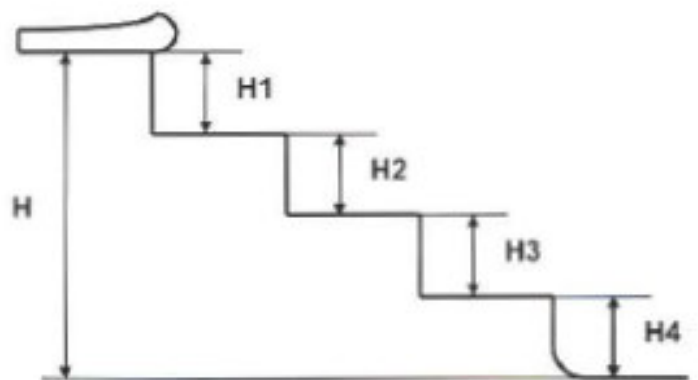
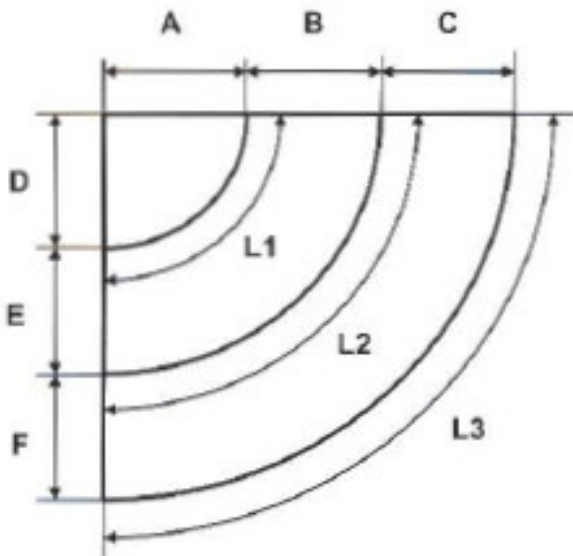

L1	L2	L3

A	B	C	D	E	F

H	H1	H2	H3	H4

Verificar que  $H1 + H2 + H3 + H4 = H$

Pedido

Presupuesto

**EMISOR**

Fecha : .....

Ref. Cliente : .....

**ESCALERA OBLICUA DERECHA**

**Opción**

Anti-Deslizante Azul Claro	<input type="checkbox"/>
Anti-Deslizante Arena	<input type="checkbox"/>

**Posición de la Escalera**

Baño Pequeño	Baño Grande
--------------	-------------

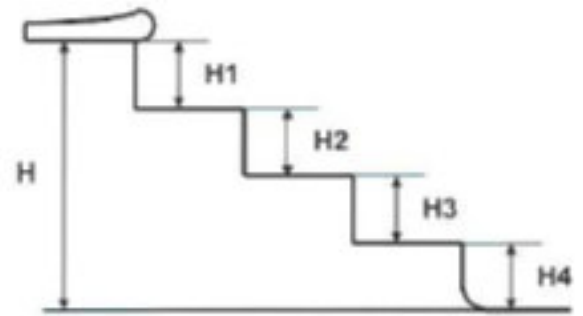
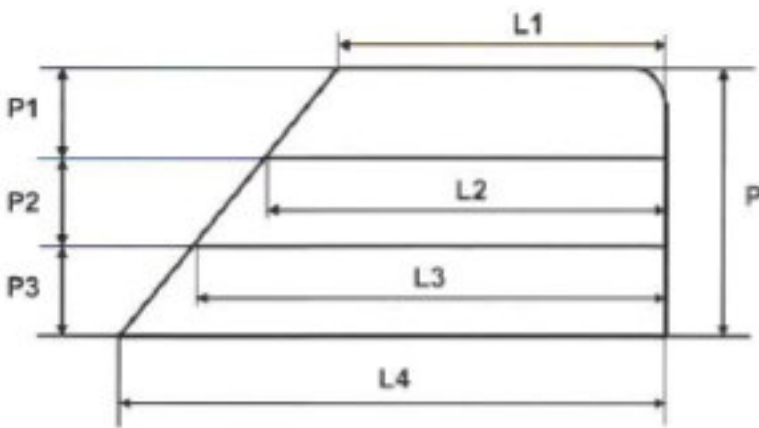

L1	L2	L3	L4

P	P1	P2	P3

Verificar que  $P1 + P2 + P3 = P$

H	H1	H2	H3	H4

Verificar que  $H1 + H2 + H3 + H4 = H$

Pedido

Presupuesto

**EMISOR**

Fecha : .....

Ref. Cliente : .....

**ESCALERA OBLICUA IZQUIERDA**

**Opción**

Anti-Deslizante Azul Claro	<input type="checkbox"/>
Anti-Deslizante Arena	<input type="checkbox"/>

**Posición de la Escalera**

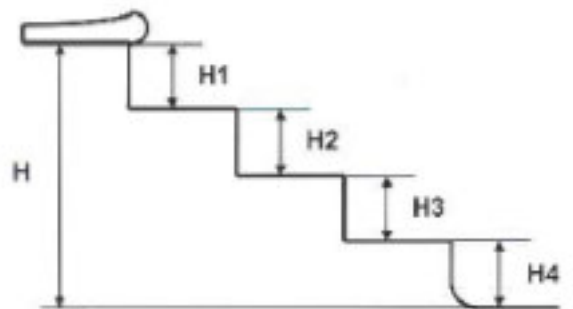
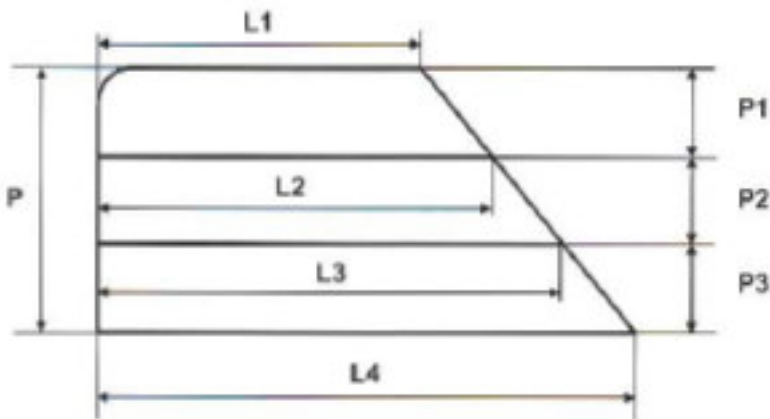

L1	L2	L3	L4

P	P1	P2	P3

Verificar que  $P1 + P2 + P3 = P$

H	H1	H2	H3	H4

Verificar que  $H1 + H2 + H3 + H4 = H$

# DAYAMON POOL

# Escalera

Pedido

Presupuesto

**EMISOR**

Fecha : .....

Ref. Cliente : .....

**ESCALERA RECTA 3 PELDAÑOS**

Opción	
Anti-Deslizante Azul Claro	<input type="checkbox"/>
Anti-Deslizante Arena	<input type="checkbox"/>

**Posición de la Escalera**

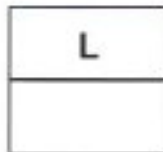
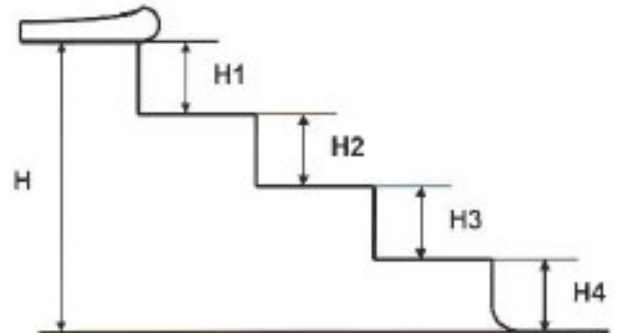
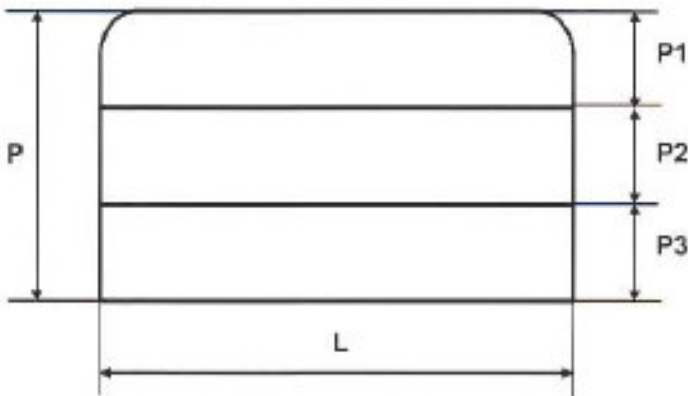
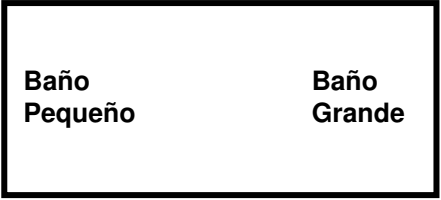

P	P1	P2	P3

Verificar que  $P1 + P2 + P3 = P$

H	H1	H2	H3	H4

Verificar que  $H1 + H2 + H3 + H4 = H$

# DAYAMON POOL

# Escalera

Pedido

Presupuesto

**EMISOR**

Fecha : .....

Ref. Cliente : .....

## ESCALERA RECTA 4 PELDAÑOS

### Opción

Anti-Deslizante Azul Claro	<input type="checkbox"/>
Anti-Deslizante Arena	<input type="checkbox"/>

### Posición de la Escalera

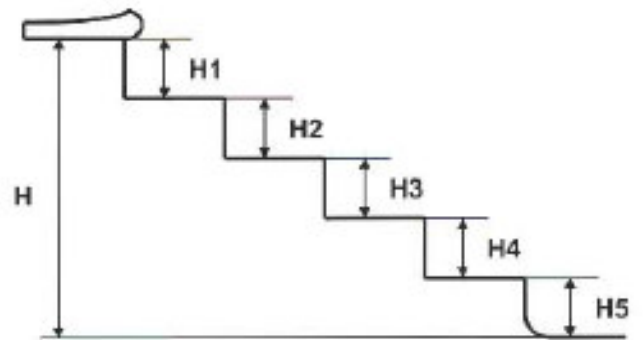
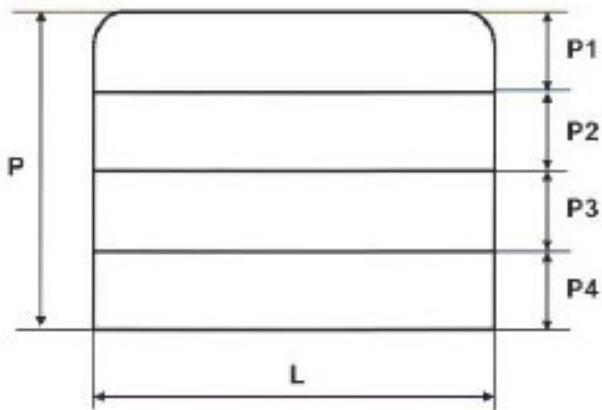

P	P1	P2	P3	P4

Verificar que  $P1 + P2 + P3 + P4 = P$

H	H1	H2	H3	H4	H5

Verificar que  $H1 + H2 + H3 + H4 + H5 = H$

# DAYAMON POOL

# Escalera

Pedido

Presupuesto

**EMISOR**

Fecha : .....

Ref. Cliente : .....

## ESCALERA ROMANA 4 PELDAÑOS

### Opción

Anti-Deslizante Azul Claro	<input type="checkbox"/>
Anti-Deslizante Arena	<input type="checkbox"/>

### Posición de la Escalera

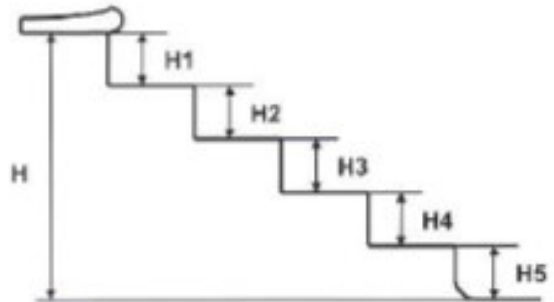
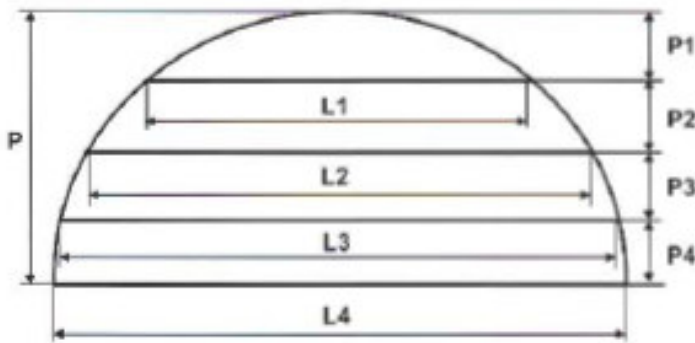
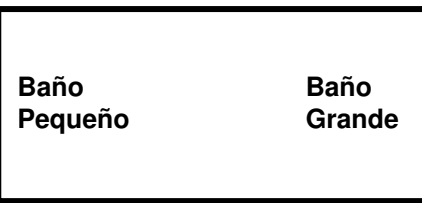

L1	L2	L3	L4

P	P1	P2	P3	P4

Verificar que  $P1 + P2 + P3 + P4 = P$

H	H1	H2	H3	H4	H5

Verificar que  $H1 + H2 + H3 + H4 + H5 = H$

# DAYAMON POOL

# Escalera

Pedido

Presupuesto

**EMISOR**

Fecha : .....

Ref. Cliente : .....

## ESCALERA ROMANA 3 PELDAÑOS

### Opción

Anti-Deslizante Azul Claro	<input type="checkbox"/>
Anti-Deslizante Arena	<input type="checkbox"/>

### Posición de la Escalera

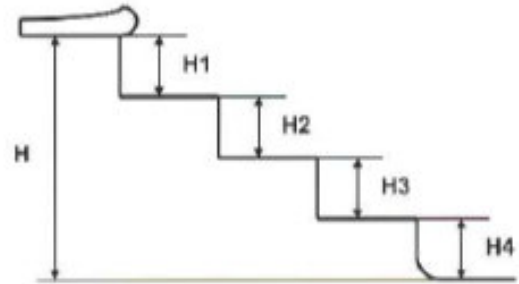
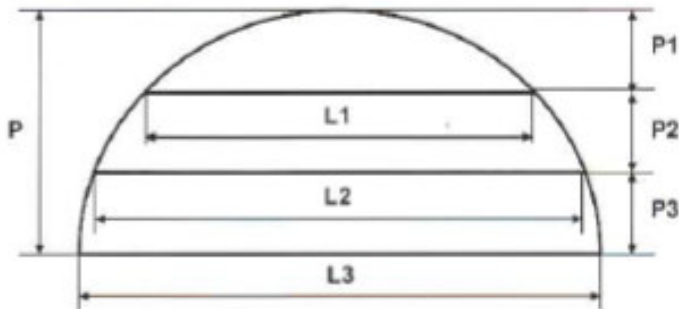

L1	L2	L3

P	P1	P2	P3

Verificar que  $P1 + P2 + P3 = P$

H	H1	H2	H3	H4

Verificar que  $H1 + H2 + H3 + H4 = H$

# DAYAMON POOL

Liner

Pedido

Presupuesto

**EMISOR**

Fecha : .....

Ref. Cliente : .....

Cenefa	Azul	Verde	Ocre
Carthago	<input type="checkbox"/>	<input type="checkbox"/>	<input type="checkbox"/>
Pompeya	<input type="checkbox"/>	<input type="checkbox"/>	<input type="checkbox"/>
Mykonos	<input type="checkbox"/>	<input type="checkbox"/>	<input type="checkbox"/>
Olympia	<input type="checkbox"/>	<input type="checkbox"/>	<input type="checkbox"/>
Caribe	<input type="checkbox"/>	<input type="checkbox"/>	<input type="checkbox"/>
Alegro	<input type="checkbox"/>	<input type="checkbox"/>	<input type="checkbox"/>
Colonia	<input type="checkbox"/>	<input type="checkbox"/>	<input type="checkbox"/>
Navalon	<input type="checkbox"/>	<input type="checkbox"/>	<input type="checkbox"/>
Sebastian	<input type="checkbox"/>	<input type="checkbox"/>	<input type="checkbox"/>
Mosaico	<input type="checkbox"/>	<input type="checkbox"/>	<input type="checkbox"/>
Florentina	<input type="checkbox"/>	<input type="checkbox"/>	<input type="checkbox"/>
Benedicta	<input type="checkbox"/>	<input type="checkbox"/>	<input type="checkbox"/>
Rocas	<input type="checkbox"/>	<input type="checkbox"/>	<input type="checkbox"/>
Boreal	<input type="checkbox"/>	<input type="checkbox"/>	<input type="checkbox"/>

Muros Estampados	
Wyndham	<input type="checkbox"/>
Lexington Wall	<input type="checkbox"/>
Lankshire Wall	<input type="checkbox"/>
Caribe	<input type="checkbox"/>
Dacota	<input type="checkbox"/>

Colores Lisos	
Azul France	<input type="checkbox"/>
Azul Claro	<input type="checkbox"/>
Verde Caribe	<input type="checkbox"/>
Blanco	<input type="checkbox"/>
Arena	<input type="checkbox"/>
Negro	<input type="checkbox"/>
Gris	<input type="checkbox"/>

Colores Estampados	
Mosaico	<input type="checkbox"/>
Servana	<input type="checkbox"/>
Mármol Azul	<input type="checkbox"/>
Mármol Verde	<input type="checkbox"/>
Mármol Arena	<input type="checkbox"/>
Bizantino Azul	<input type="checkbox"/>
BizantinoVerde	<input type="checkbox"/>

<b>Perfil</b>	Hung	<input type="checkbox"/>	Otra	
<b>Espesor</b>	75/100	<input type="checkbox"/>	Otra	
<b>Radio Vert.</b>	15 cm	<input type="checkbox"/>	Otra	
<b>Radio Hori.</b>	5 cm	<input type="checkbox"/>	Otra	

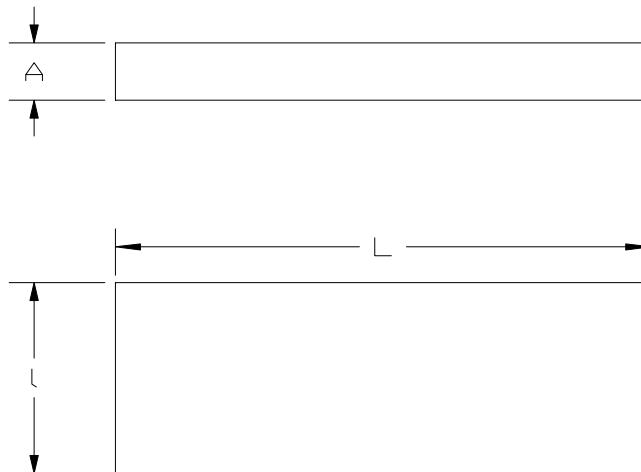

L	I	A

# DAYAMON POOL

Liner

Pedido

Presupuesto

**EMISOR**

Fecha : .....

Ref. Cliente : .....

Cenefa	Azul	Verde	Ocre
Carthago	<input type="checkbox"/>	<input type="checkbox"/>	<input type="checkbox"/>
Pompeya	<input type="checkbox"/>	<input type="checkbox"/>	<input type="checkbox"/>
Mykonos	<input type="checkbox"/>	<input type="checkbox"/>	<input type="checkbox"/>
Olympia	<input type="checkbox"/>	<input type="checkbox"/>	<input type="checkbox"/>
Caribe	<input type="checkbox"/>	<input type="checkbox"/>	<input type="checkbox"/>
Alegro	<input type="checkbox"/>	<input type="checkbox"/>	<input type="checkbox"/>
Colonia	<input type="checkbox"/>	<input type="checkbox"/>	<input type="checkbox"/>
Navalon	<input type="checkbox"/>	<input type="checkbox"/>	<input type="checkbox"/>
Sebastian	<input type="checkbox"/>	<input type="checkbox"/>	<input type="checkbox"/>
Mosaico	<input type="checkbox"/>	<input type="checkbox"/>	<input type="checkbox"/>
Florentina	<input type="checkbox"/>	<input type="checkbox"/>	<input type="checkbox"/>
Benedicta	<input type="checkbox"/>	<input type="checkbox"/>	<input type="checkbox"/>
Rocas	<input type="checkbox"/>	<input type="checkbox"/>	<input type="checkbox"/>
Boreal	<input type="checkbox"/>	<input type="checkbox"/>	<input type="checkbox"/>

Muros Estampados	
Wyndham	<input type="checkbox"/>
Lexington Wall	<input type="checkbox"/>
Lankshire Wall	<input type="checkbox"/>
Caribe	<input type="checkbox"/>
Dacota	<input type="checkbox"/>

Colores Lisos	
Azul France	<input type="checkbox"/>
Azul Claro	<input type="checkbox"/>
Verde Caribe	<input type="checkbox"/>
Blanco	<input type="checkbox"/>
Arena	<input type="checkbox"/>
Negro	<input type="checkbox"/>
Gris	<input type="checkbox"/>

Colores Estampados	
Mosaico	<input type="checkbox"/>
Servana	<input type="checkbox"/>
Mármol Azul	<input type="checkbox"/>
Mármol Verde	<input type="checkbox"/>
Mármol Arena	<input type="checkbox"/>
Bizantino Azul	<input type="checkbox"/>
BizantinoVerde	<input type="checkbox"/>

<b>Perfil</b>	Hung	<input type="checkbox"/>	Otra	
<b>Espesor</b>	75/100	<input type="checkbox"/>	Otra	
<b>Radio Vert.</b>	15 cm	<input type="checkbox"/>	Otra	
<b>Radio Hori.</b>	5 cm	<input type="checkbox"/>	Otra	

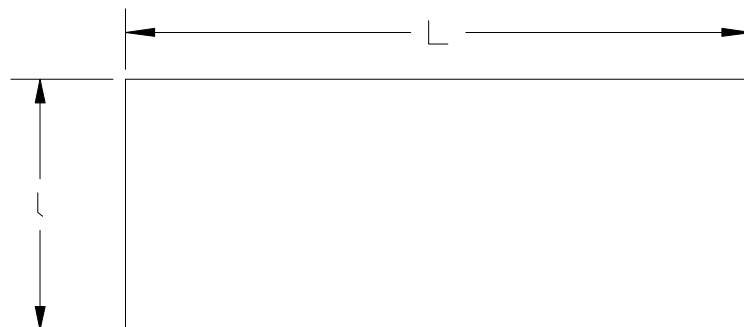

L	I	A	B

# DAYAMON POOL

Liner

Pedido

Presupuesto

**EMISOR**

Fecha : .....

Ref. Cliente : .....

Cenefa	Azul	Verde	Ocre
Carthago	<input type="checkbox"/>	<input type="checkbox"/>	<input type="checkbox"/>
Pompeya	<input type="checkbox"/>	<input type="checkbox"/>	<input type="checkbox"/>
Mykonos	<input type="checkbox"/>	<input type="checkbox"/>	<input type="checkbox"/>
Olympia	<input type="checkbox"/>	<input type="checkbox"/>	<input type="checkbox"/>
Caribe	<input type="checkbox"/>	<input type="checkbox"/>	<input type="checkbox"/>
Alegro	<input type="checkbox"/>	<input type="checkbox"/>	<input type="checkbox"/>
Colonia	<input type="checkbox"/>	<input type="checkbox"/>	<input type="checkbox"/>
Navalon	<input type="checkbox"/>	<input type="checkbox"/>	<input type="checkbox"/>
Sebastian	<input type="checkbox"/>	<input type="checkbox"/>	<input type="checkbox"/>
Mosaico	<input type="checkbox"/>	<input type="checkbox"/>	<input type="checkbox"/>
Florentina	<input type="checkbox"/>	<input type="checkbox"/>	<input type="checkbox"/>
Benedicta	<input type="checkbox"/>	<input type="checkbox"/>	<input type="checkbox"/>
Rocas	<input type="checkbox"/>	<input type="checkbox"/>	<input type="checkbox"/>
Boreal	<input type="checkbox"/>	<input type="checkbox"/>	<input type="checkbox"/>

Muros Estampados	
Wyndham	<input type="checkbox"/>
Lexington Wall	<input type="checkbox"/>
Lankshire Wall	<input type="checkbox"/>
Caribe	<input type="checkbox"/>
Dacota	<input type="checkbox"/>

Colores Lisos	
Azul France	<input type="checkbox"/>
Azul Claro	<input type="checkbox"/>
Verde Caribe	<input type="checkbox"/>
Blanco	<input type="checkbox"/>
Arena	<input type="checkbox"/>
Negro	<input type="checkbox"/>
Gris	<input type="checkbox"/>

Colores Estampados	
Mosaico	<input type="checkbox"/>
Servana	<input type="checkbox"/>
Mármol Azul	<input type="checkbox"/>
Mármol Verde	<input type="checkbox"/>
Mármol Arena	<input type="checkbox"/>
Bizantino Azul	<input type="checkbox"/>
BizantinoVerde	<input type="checkbox"/>

<b>Perfil</b>	Hung	<input type="checkbox"/>	Otra	
<b>Espesor</b>	75/100	<input type="checkbox"/>	Otra	
<b>Radio Vert.</b>	15 cm	<input type="checkbox"/>	Otra	
<b>Radio Hori.</b>	5 cm	<input type="checkbox"/>	Otra	

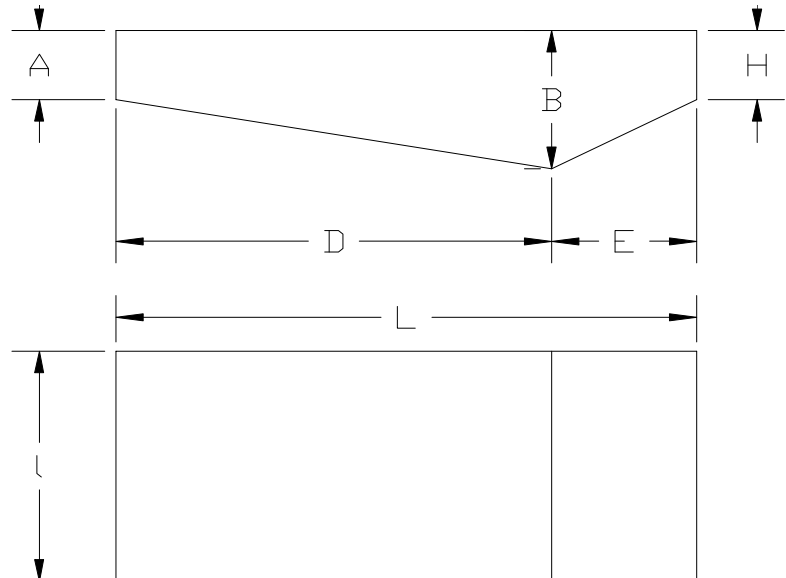

L	I	A	B	D	E	H

Verificar  $D + E = L$

# DAYAMON POOL

Liner

Pedido

Presupuesto

**EMISOR**

Fecha : .....

Ref. Cliente : .....

Cenefa	Azul	Verde	Ocre
Carthago	<input type="checkbox"/>	<input type="checkbox"/>	<input type="checkbox"/>
Pompeya	<input type="checkbox"/>	<input type="checkbox"/>	<input type="checkbox"/>
Mykonos	<input type="checkbox"/>	<input type="checkbox"/>	<input type="checkbox"/>
Olympia	<input type="checkbox"/>	<input type="checkbox"/>	<input type="checkbox"/>
Caribe	<input type="checkbox"/>	<input type="checkbox"/>	<input type="checkbox"/>
Alegro	<input type="checkbox"/>	<input type="checkbox"/>	<input type="checkbox"/>
Colonia	<input type="checkbox"/>	<input type="checkbox"/>	<input type="checkbox"/>
Navalon	<input type="checkbox"/>	<input type="checkbox"/>	<input type="checkbox"/>
Sebastian	<input type="checkbox"/>	<input type="checkbox"/>	<input type="checkbox"/>
Mosaico	<input type="checkbox"/>	<input type="checkbox"/>	<input type="checkbox"/>
Florentina	<input type="checkbox"/>	<input type="checkbox"/>	<input type="checkbox"/>
Benedicta	<input type="checkbox"/>	<input type="checkbox"/>	<input type="checkbox"/>
Rocas	<input type="checkbox"/>	<input type="checkbox"/>	<input type="checkbox"/>
Boreal	<input type="checkbox"/>	<input type="checkbox"/>	<input type="checkbox"/>

Muros Estampados	
Wyndham	<input type="checkbox"/>
Lexington Wall	<input type="checkbox"/>
Lankshire Wall	<input type="checkbox"/>
Caribe	<input type="checkbox"/>
Dacota	<input type="checkbox"/>

Colores Lisos	
Azul France	<input type="checkbox"/>
Azul Claro	<input type="checkbox"/>
Verde Caribe	<input type="checkbox"/>
Blanco	<input type="checkbox"/>
Arena	<input type="checkbox"/>
Negro	<input type="checkbox"/>
Gris	<input type="checkbox"/>

Colores Estampados	
Mosaico	<input type="checkbox"/>
Servana	<input type="checkbox"/>
Mármol Azul	<input type="checkbox"/>
Mármol Verde	<input type="checkbox"/>
Mármol Arena	<input type="checkbox"/>
Bizantino Azul	<input type="checkbox"/>
BizantinoVerde	<input type="checkbox"/>

<b>Perfil</b>	Hung	<input type="checkbox"/>	Otra	
<b>Espesor</b>	75/100	<input type="checkbox"/>	Otra	
<b>Radio Vert.</b>	15 cm	<input type="checkbox"/>	Otra	
<b>Radio Hori.</b>	5 cm	<input type="checkbox"/>	Otra	

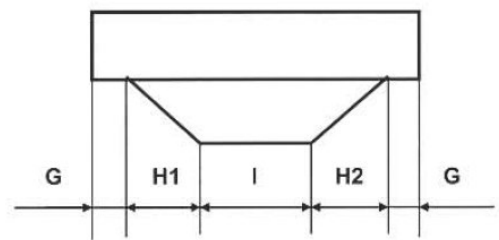
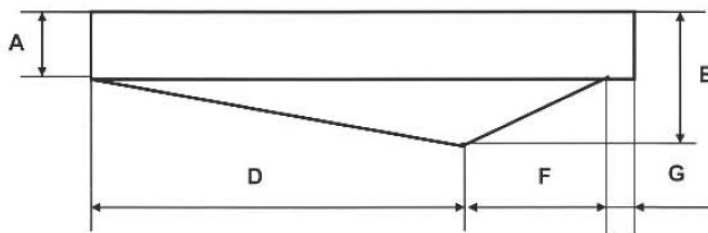
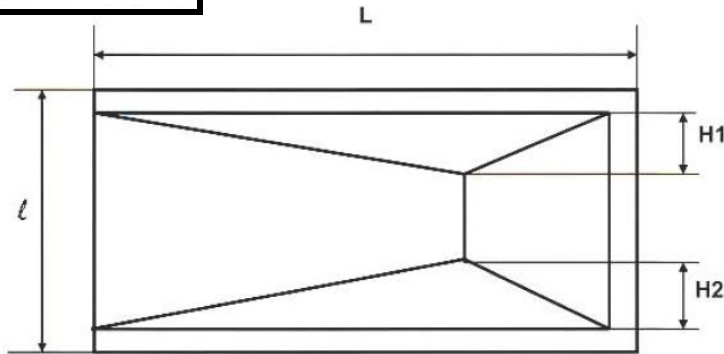

L	l	A	B

D	F	G

G	H1	I	H2	G

# DAYAMON POOL

Liner

Pedido

Presupuesto

**EMISOR**

Fecha : .....

Ref. Cliente : .....

Cenefa	Azul	Verde	Ocre
Carthago	<input type="checkbox"/>	<input type="checkbox"/>	<input type="checkbox"/>
Pompeya	<input type="checkbox"/>	<input type="checkbox"/>	<input type="checkbox"/>
Mykonos	<input type="checkbox"/>	<input type="checkbox"/>	<input type="checkbox"/>
Olympia	<input type="checkbox"/>	<input type="checkbox"/>	<input type="checkbox"/>
Caribe	<input type="checkbox"/>	<input type="checkbox"/>	<input type="checkbox"/>
Alegro	<input type="checkbox"/>	<input type="checkbox"/>	<input type="checkbox"/>
Colonia	<input type="checkbox"/>	<input type="checkbox"/>	<input type="checkbox"/>
Navalon	<input type="checkbox"/>	<input type="checkbox"/>	<input type="checkbox"/>
Sebastian	<input type="checkbox"/>	<input type="checkbox"/>	<input type="checkbox"/>
Mosaico	<input type="checkbox"/>	<input type="checkbox"/>	<input type="checkbox"/>
Florentina	<input type="checkbox"/>	<input type="checkbox"/>	<input type="checkbox"/>
Benedicta	<input type="checkbox"/>	<input type="checkbox"/>	<input type="checkbox"/>
Rocas	<input type="checkbox"/>	<input type="checkbox"/>	<input type="checkbox"/>
Boreal	<input type="checkbox"/>	<input type="checkbox"/>	<input type="checkbox"/>

Muros Estampados	
Wyndham	<input type="checkbox"/>
Lexington Wall	<input type="checkbox"/>
Lankshire Wall	<input type="checkbox"/>
Caribe	<input type="checkbox"/>
Dacota	<input type="checkbox"/>

Colores Lisos	
Azul France	<input type="checkbox"/>
Azul Claro	<input type="checkbox"/>
Verde Caribe	<input type="checkbox"/>
Blanco	<input type="checkbox"/>
Arena	<input type="checkbox"/>
Negro	<input type="checkbox"/>
Gris	<input type="checkbox"/>

Colores Estampados	
Mosaico	<input type="checkbox"/>
Servana	<input type="checkbox"/>
Mármol Azul	<input type="checkbox"/>
Mármol Verde	<input type="checkbox"/>
Mármol Arena	<input type="checkbox"/>
Bizantino Azul	<input type="checkbox"/>
BizantinoVerde	<input type="checkbox"/>

<b>Perfil</b>	Hung	<input type="checkbox"/>	Otra	
<b>Espesor</b>	75/100	<input type="checkbox"/>	Otra	
<b>Radio Vert.</b>	15 cm	<input type="checkbox"/>	Otra	
<b>Radio Hori.</b>	5 cm	<input type="checkbox"/>	Otra	

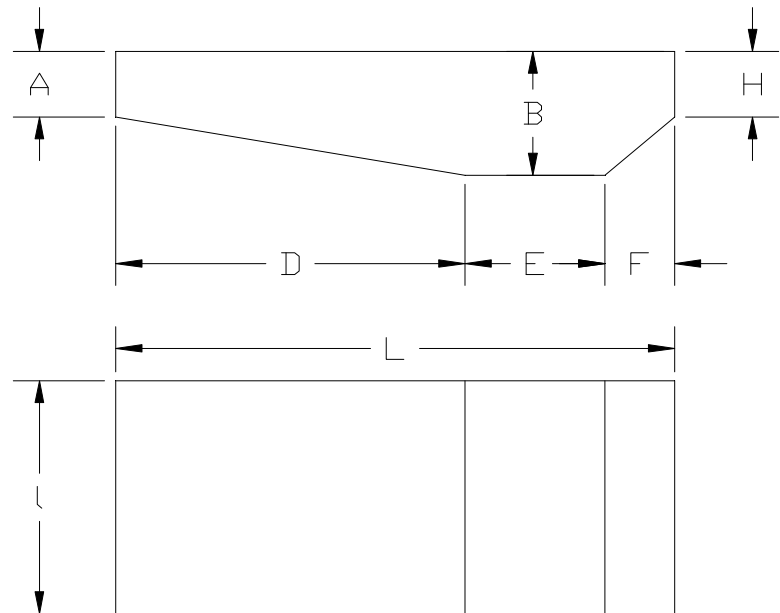

L	I	A	B	D	E	F	H

Verificar  $D + E + F = L$

# DAYAMON POOL

Liner

Pedido

Presupuesto

**EMISOR**

Fecha : .....

Ref. Cliente : .....

Cenefa	Azul	Verde	Ocre
Carthago	<input type="checkbox"/>	<input type="checkbox"/>	<input type="checkbox"/>
Pompeya	<input type="checkbox"/>	<input type="checkbox"/>	<input type="checkbox"/>
Mykonos	<input type="checkbox"/>	<input type="checkbox"/>	<input type="checkbox"/>
Olympia	<input type="checkbox"/>	<input type="checkbox"/>	<input type="checkbox"/>
Caribe	<input type="checkbox"/>	<input type="checkbox"/>	<input type="checkbox"/>
Alegro	<input type="checkbox"/>	<input type="checkbox"/>	<input type="checkbox"/>
Colonia	<input type="checkbox"/>	<input type="checkbox"/>	<input type="checkbox"/>
Navalon	<input type="checkbox"/>	<input type="checkbox"/>	<input type="checkbox"/>
Sebastian	<input type="checkbox"/>	<input type="checkbox"/>	<input type="checkbox"/>
Mosaico	<input type="checkbox"/>	<input type="checkbox"/>	<input type="checkbox"/>
Florentina	<input type="checkbox"/>	<input type="checkbox"/>	<input type="checkbox"/>
Benedicta	<input type="checkbox"/>	<input type="checkbox"/>	<input type="checkbox"/>
Rocas	<input type="checkbox"/>	<input type="checkbox"/>	<input type="checkbox"/>
Boreal	<input type="checkbox"/>	<input type="checkbox"/>	<input type="checkbox"/>

Muros Estampados	
Wyndham	<input type="checkbox"/>
Lexington Wall	<input type="checkbox"/>
Lankshire Wall	<input type="checkbox"/>
Caribe	<input type="checkbox"/>
Dacota	<input type="checkbox"/>

Colores Lisos	
Azul France	<input type="checkbox"/>
Azul Claro	<input type="checkbox"/>
Verde Caribe	<input type="checkbox"/>
Blanco	<input type="checkbox"/>
Arena	<input type="checkbox"/>
Negro	<input type="checkbox"/>
Gris	<input type="checkbox"/>

Colores Estampados	
Mosaico	<input type="checkbox"/>
Servana	<input type="checkbox"/>
Mármol Azul	<input type="checkbox"/>
Mármol Verde	<input type="checkbox"/>
Mármol Arena	<input type="checkbox"/>
Bizantino Azul	<input type="checkbox"/>
BizantinoVerde	<input type="checkbox"/>

<b>Perfil</b>	Hung	<input type="checkbox"/>	Otra	
<b>Espesor</b>	75/100	<input type="checkbox"/>	Otra	
<b>Radio Vert.</b>	15 cm	<input type="checkbox"/>	Otra	
<b>Radio Hori.</b>	5 cm	<input type="checkbox"/>	Otra	

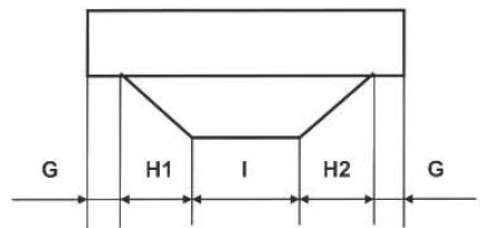
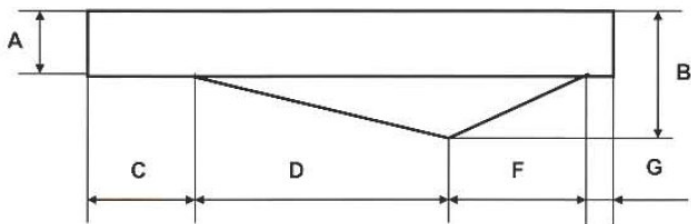
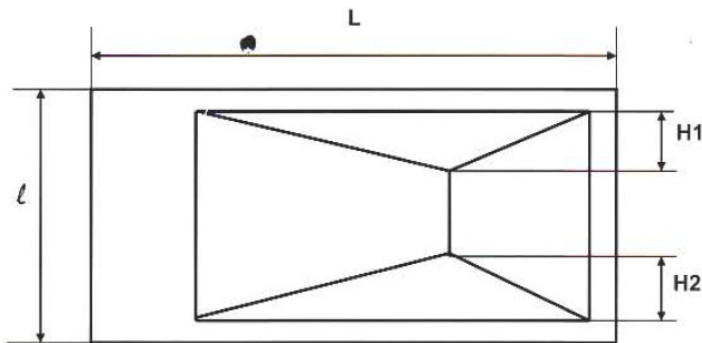

L	l	A	B

C	D	F	G

G	H1	I	H2	G

# DAYAMON POOL

Liner

Pedido

Presupuesto

**EMISOR**

Fecha : .....

Ref. Cliente : .....

Cenefa	Azul	Verde	Ocre
Carthago	<input type="checkbox"/>	<input type="checkbox"/>	<input type="checkbox"/>
Pompeya	<input type="checkbox"/>	<input type="checkbox"/>	<input type="checkbox"/>
Mykonos	<input type="checkbox"/>	<input type="checkbox"/>	<input type="checkbox"/>
Olympia	<input type="checkbox"/>	<input type="checkbox"/>	<input type="checkbox"/>
Caribe	<input type="checkbox"/>	<input type="checkbox"/>	<input type="checkbox"/>
Alegro	<input type="checkbox"/>	<input type="checkbox"/>	<input type="checkbox"/>
Colonia	<input type="checkbox"/>	<input type="checkbox"/>	<input type="checkbox"/>
Navalon	<input type="checkbox"/>	<input type="checkbox"/>	<input type="checkbox"/>
Sebastian	<input type="checkbox"/>	<input type="checkbox"/>	<input type="checkbox"/>
Mosaico	<input type="checkbox"/>	<input type="checkbox"/>	<input type="checkbox"/>
Florentina	<input type="checkbox"/>	<input type="checkbox"/>	<input type="checkbox"/>
Benedicta	<input type="checkbox"/>	<input type="checkbox"/>	<input type="checkbox"/>
Rocas	<input type="checkbox"/>	<input type="checkbox"/>	<input type="checkbox"/>
Boreal	<input type="checkbox"/>	<input type="checkbox"/>	<input type="checkbox"/>

Muros Estampados	
Wyndham	<input type="checkbox"/>
Lexington Wall	<input type="checkbox"/>
Lankshire Wall	<input type="checkbox"/>
Caribe	<input type="checkbox"/>
Dacota	<input type="checkbox"/>

Colores Lisos	
Azul France	<input type="checkbox"/>
Azul Claro	<input type="checkbox"/>
Verde Caribe	<input type="checkbox"/>
Blanco	<input type="checkbox"/>
Arena	<input type="checkbox"/>
Negro	<input type="checkbox"/>
Gris	<input type="checkbox"/>

Colores Estampados	
Mosaico	<input type="checkbox"/>
Servana	<input type="checkbox"/>
Mármol Azul	<input type="checkbox"/>
Mármol Verde	<input type="checkbox"/>
Mármol Arena	<input type="checkbox"/>
Bizantino Azul	<input type="checkbox"/>
BizantinoVerde	<input type="checkbox"/>

<b>Perfil</b>	Hung	<input type="checkbox"/>	Otra	
<b>Espesor</b>	75/100	<input type="checkbox"/>	Otra	
<b>Radio Vert.</b>	15 cm	<input type="checkbox"/>	Otra	
<b>Radio Hori.</b>	5 cm	<input type="checkbox"/>	Otra	

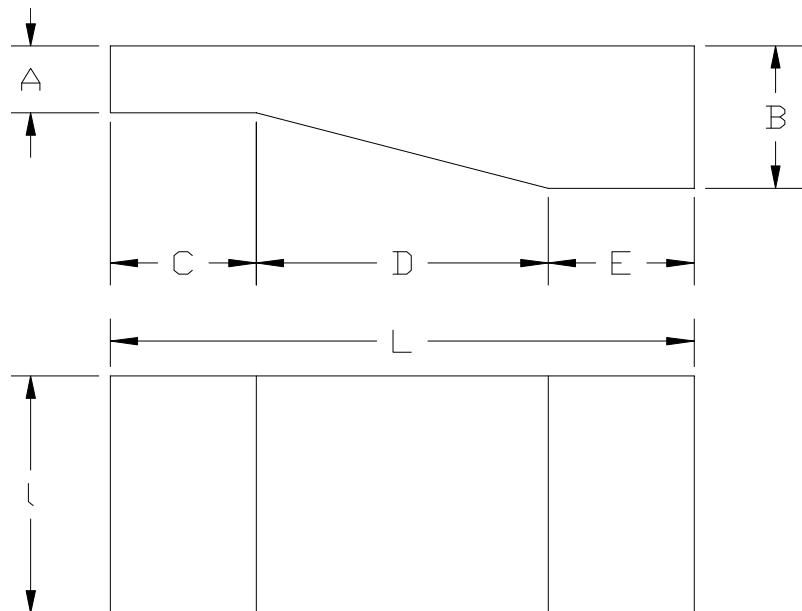

L	I	A	B	C	D	E

**Verificar C + D + E = L**

# DAYAMON POOL

Liner

Pedido

Presupuesto

**EMISOR**

Fecha : .....

Ref. Cliente : .....

Cenefa	Azul	Verde	Ocre
Carthago	<input type="checkbox"/>	<input type="checkbox"/>	<input type="checkbox"/>
Pompeya	<input type="checkbox"/>	<input type="checkbox"/>	<input type="checkbox"/>
Mykonos	<input type="checkbox"/>	<input type="checkbox"/>	<input type="checkbox"/>
Olympia	<input type="checkbox"/>	<input type="checkbox"/>	<input type="checkbox"/>
Caribe	<input type="checkbox"/>	<input type="checkbox"/>	<input type="checkbox"/>
Alegro	<input type="checkbox"/>	<input type="checkbox"/>	<input type="checkbox"/>
Colonia	<input type="checkbox"/>	<input type="checkbox"/>	<input type="checkbox"/>
Navalon	<input type="checkbox"/>	<input type="checkbox"/>	<input type="checkbox"/>
Sebastian	<input type="checkbox"/>	<input type="checkbox"/>	<input type="checkbox"/>
Mosaico	<input type="checkbox"/>	<input type="checkbox"/>	<input type="checkbox"/>
Florentina	<input type="checkbox"/>	<input type="checkbox"/>	<input type="checkbox"/>
Benedicta	<input type="checkbox"/>	<input type="checkbox"/>	<input type="checkbox"/>
Rocas	<input type="checkbox"/>	<input type="checkbox"/>	<input type="checkbox"/>
Boreal	<input type="checkbox"/>	<input type="checkbox"/>	<input type="checkbox"/>

Muros Estampados	
Wyndham	<input type="checkbox"/>
Lexington Wall	<input type="checkbox"/>
Lankshire Wall	<input type="checkbox"/>
Caribe	<input type="checkbox"/>
Dacota	<input type="checkbox"/>

Colores Lisos	
Azul France	<input type="checkbox"/>
Azul Claro	<input type="checkbox"/>
Verde Caribe	<input type="checkbox"/>
Blanco	<input type="checkbox"/>
Arena	<input type="checkbox"/>
Negro	<input type="checkbox"/>
Gris	<input type="checkbox"/>

Colores Estampados	
Mosaico	<input type="checkbox"/>
Servana	<input type="checkbox"/>
Mármol Azul	<input type="checkbox"/>
Mármol Verde	<input type="checkbox"/>
Mármol Arena	<input type="checkbox"/>
Bizantino Azul	<input type="checkbox"/>
BizantinoVerde	<input type="checkbox"/>

<b>Perfil</b>	Hung	<input type="checkbox"/>	Otra	
<b>Espesor</b>	75/100	<input type="checkbox"/>	Otra	
<b>Radio Vert.</b>	15 cm	<input type="checkbox"/>	Otra	
<b>Radio Hori.</b>	5 cm	<input type="checkbox"/>	Otra	

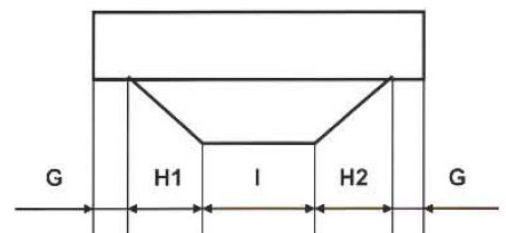
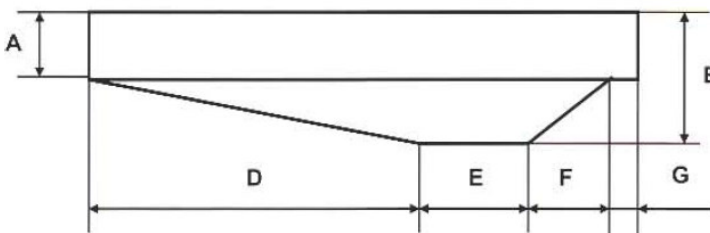
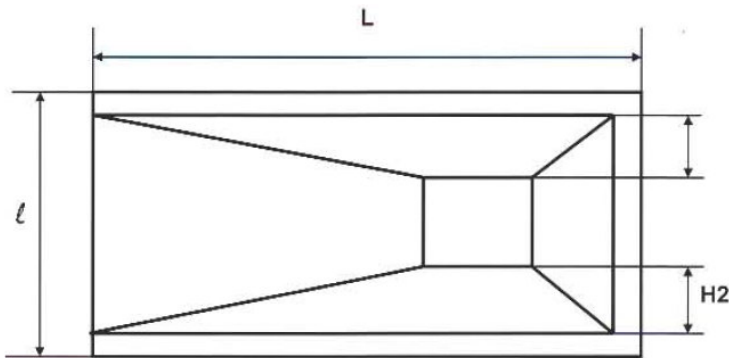

L	l	A	B

D	E	F	G

G	H1	I	H2	G

# DAYAMON POOL

Liner

Pedido

Presupuesto

**EMISOR**

Fecha : .....

Ref. Cliente : .....

Cenefa	Azul	Verde	Ocre
Carthago	<input type="checkbox"/>	<input type="checkbox"/>	<input type="checkbox"/>
Pompeya	<input type="checkbox"/>	<input type="checkbox"/>	<input type="checkbox"/>
Mykonos	<input type="checkbox"/>	<input type="checkbox"/>	<input type="checkbox"/>
Olympia	<input type="checkbox"/>	<input type="checkbox"/>	<input type="checkbox"/>
Caribe	<input type="checkbox"/>	<input type="checkbox"/>	<input type="checkbox"/>
Alegro	<input type="checkbox"/>	<input type="checkbox"/>	<input type="checkbox"/>
Colonia	<input type="checkbox"/>	<input type="checkbox"/>	<input type="checkbox"/>
Navalon	<input type="checkbox"/>	<input type="checkbox"/>	<input type="checkbox"/>
Sebastian	<input type="checkbox"/>	<input type="checkbox"/>	<input type="checkbox"/>
Mosaico	<input type="checkbox"/>	<input type="checkbox"/>	<input type="checkbox"/>
Florentina	<input type="checkbox"/>	<input type="checkbox"/>	<input type="checkbox"/>
Benedicta	<input type="checkbox"/>	<input type="checkbox"/>	<input type="checkbox"/>
Rocas	<input type="checkbox"/>	<input type="checkbox"/>	<input type="checkbox"/>
Boreal	<input type="checkbox"/>	<input type="checkbox"/>	<input type="checkbox"/>

Muros Estampados	
Wyndham	<input type="checkbox"/>
Lexington Wall	<input type="checkbox"/>
Lankshire Wall	<input type="checkbox"/>
Caribe	<input type="checkbox"/>
Dacota	<input type="checkbox"/>

Colores Lisos	
Azul France	<input type="checkbox"/>
Azul Claro	<input type="checkbox"/>
Verde Caribe	<input type="checkbox"/>
Blanco	<input type="checkbox"/>
Arena	<input type="checkbox"/>
Negro	<input type="checkbox"/>
Gris	<input type="checkbox"/>

Colores Estampados	
Mosaico	<input type="checkbox"/>
Servana	<input type="checkbox"/>
Mármol Azul	<input type="checkbox"/>
Mármol Verde	<input type="checkbox"/>
Mármol Arena	<input type="checkbox"/>
Bizantino Azul	<input type="checkbox"/>
BizantinoVerde	<input type="checkbox"/>

<b>Perfil</b>	Hung	<input type="checkbox"/>	Otra	
<b>Espesor</b>	75/100	<input type="checkbox"/>	Otra	
<b>Radio Vert.</b>	15 cm	<input type="checkbox"/>	Otra	
<b>Radio Hori.</b>	5 cm	<input type="checkbox"/>	Otra	

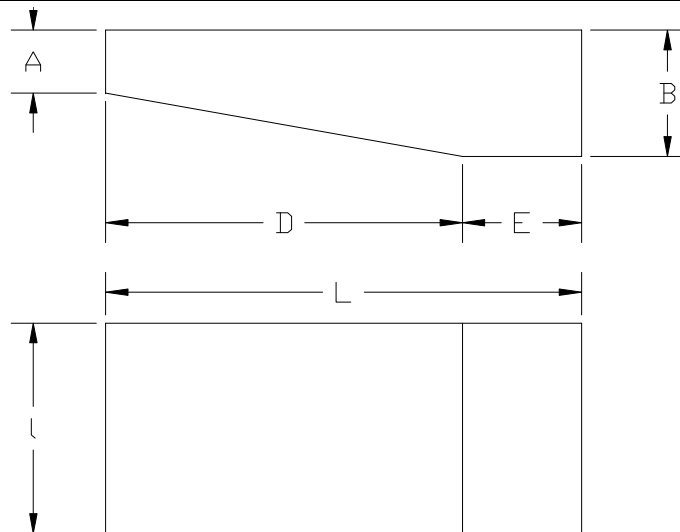

L	I	A	B	D	E

Verificar  $D + E = L$

# DAYAMON POOL

Liner

Pedido

Presupuesto

**EMISOR**

Fecha : .....

Ref. Cliente : .....

Cenefa	Azul	Verde	Ocre
Carthago	<input type="checkbox"/>	<input type="checkbox"/>	<input type="checkbox"/>
Pompeya	<input type="checkbox"/>	<input type="checkbox"/>	<input type="checkbox"/>
Mykonos	<input type="checkbox"/>	<input type="checkbox"/>	<input type="checkbox"/>
Olympia	<input type="checkbox"/>	<input type="checkbox"/>	<input type="checkbox"/>
Caribe	<input type="checkbox"/>	<input type="checkbox"/>	<input type="checkbox"/>
Alegro	<input type="checkbox"/>	<input type="checkbox"/>	<input type="checkbox"/>
Colonia	<input type="checkbox"/>	<input type="checkbox"/>	<input type="checkbox"/>
Navalon	<input type="checkbox"/>	<input type="checkbox"/>	<input type="checkbox"/>
Sebastian	<input type="checkbox"/>	<input type="checkbox"/>	<input type="checkbox"/>
Mosaico	<input type="checkbox"/>	<input type="checkbox"/>	<input type="checkbox"/>
Florentina	<input type="checkbox"/>	<input type="checkbox"/>	<input type="checkbox"/>
Benedicta	<input type="checkbox"/>	<input type="checkbox"/>	<input type="checkbox"/>
Rocas	<input type="checkbox"/>	<input type="checkbox"/>	<input type="checkbox"/>
Boreal	<input type="checkbox"/>	<input type="checkbox"/>	<input type="checkbox"/>

Muros Estampados	
Wyndham	<input type="checkbox"/>
Lexington Wall	<input type="checkbox"/>
Lankshire Wall	<input type="checkbox"/>
Caribe	<input type="checkbox"/>
Dacota	<input type="checkbox"/>

Colores Lisos	
Azul France	<input type="checkbox"/>
Azul Claro	<input type="checkbox"/>
Verde Caribe	<input type="checkbox"/>
Blanco	<input type="checkbox"/>
Arena	<input type="checkbox"/>
Negro	<input type="checkbox"/>
Gris	<input type="checkbox"/>

Colores Estampados	
Mosaico	<input type="checkbox"/>
Servana	<input type="checkbox"/>
Mármol Azul	<input type="checkbox"/>
Mármol Verde	<input type="checkbox"/>
Mármol Arena	<input type="checkbox"/>
Bizantino Azul	<input type="checkbox"/>
BizantinoVerde	<input type="checkbox"/>

<b>Perfil</b>	Hung	<input type="checkbox"/>	Otra	
<b>Espesor</b>	75/100	<input type="checkbox"/>	Otra	
<b>Radio Vert.</b>	15 cm	<input type="checkbox"/>	Otra	
<b>Radio Hori.</b>	5 cm	<input type="checkbox"/>	Otra	

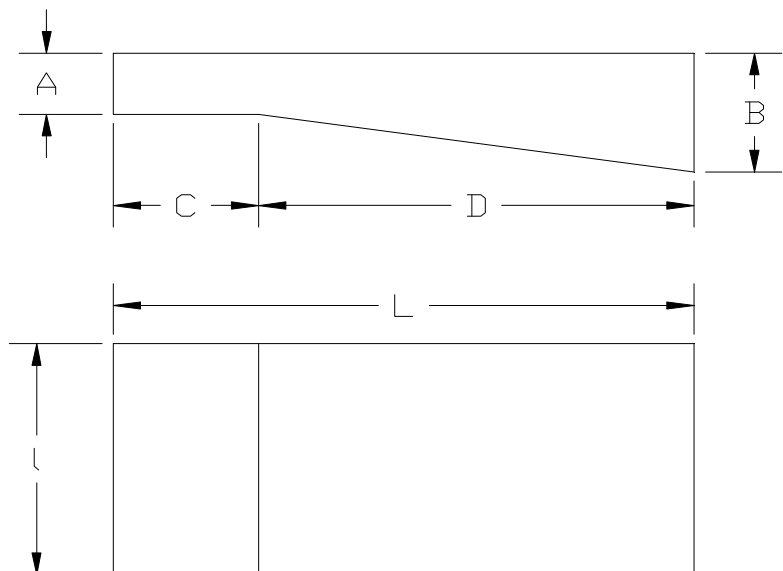

L	I	A	B	C	D

Verificar  $C + D = L$

# DAYAMON POOL

Liner

Pedido

Presupuesto

**EMISOR**

Fecha : .....

Ref. Cliente : .....

Cenefa	Azul	Verde	Ocre
Carthago	<input type="checkbox"/>	<input type="checkbox"/>	<input type="checkbox"/>
Pompeya	<input type="checkbox"/>	<input type="checkbox"/>	<input type="checkbox"/>
Mykonos	<input type="checkbox"/>	<input type="checkbox"/>	<input type="checkbox"/>
Olympia	<input type="checkbox"/>	<input type="checkbox"/>	<input type="checkbox"/>
Caribe	<input type="checkbox"/>	<input type="checkbox"/>	<input type="checkbox"/>
Alegro	<input type="checkbox"/>	<input type="checkbox"/>	<input type="checkbox"/>
Colonia	<input type="checkbox"/>	<input type="checkbox"/>	<input type="checkbox"/>
Navalon	<input type="checkbox"/>	<input type="checkbox"/>	<input type="checkbox"/>
Sebastian	<input type="checkbox"/>	<input type="checkbox"/>	<input type="checkbox"/>
Mosaico	<input type="checkbox"/>	<input type="checkbox"/>	<input type="checkbox"/>
Florentina	<input type="checkbox"/>	<input type="checkbox"/>	<input type="checkbox"/>
Benedicta	<input type="checkbox"/>	<input type="checkbox"/>	<input type="checkbox"/>
Rocas	<input type="checkbox"/>	<input type="checkbox"/>	<input type="checkbox"/>
Boreal	<input type="checkbox"/>	<input type="checkbox"/>	<input type="checkbox"/>

Muros Estampados	
Wyndham	<input type="checkbox"/>
Lexington Wall	<input type="checkbox"/>
Lankshire Wall	<input type="checkbox"/>
Caribe	<input type="checkbox"/>
Dacota	<input type="checkbox"/>

Colores Lisos	
Azul France	<input type="checkbox"/>
Azul Claro	<input type="checkbox"/>
Verde Caribe	<input type="checkbox"/>
Blanco	<input type="checkbox"/>
Arena	<input type="checkbox"/>
Negro	<input type="checkbox"/>
Gris	<input type="checkbox"/>

Colores Estampados	
Mosaico	<input type="checkbox"/>
Servana	<input type="checkbox"/>
Mármol Azul	<input type="checkbox"/>
Mármol Verde	<input type="checkbox"/>
Mármol Arena	<input type="checkbox"/>
Bizantino Azul	<input type="checkbox"/>
BizantinoVerde	<input type="checkbox"/>

<b>Perfil</b>	Hung	<input type="checkbox"/>	Otra	
<b>Espesor</b>	75/100	<input type="checkbox"/>	Otra	
<b>Radio Vert.</b>	15 cm	<input type="checkbox"/>	Otra	
<b>Radio Hori.</b>	5 cm	<input type="checkbox"/>	Otra	

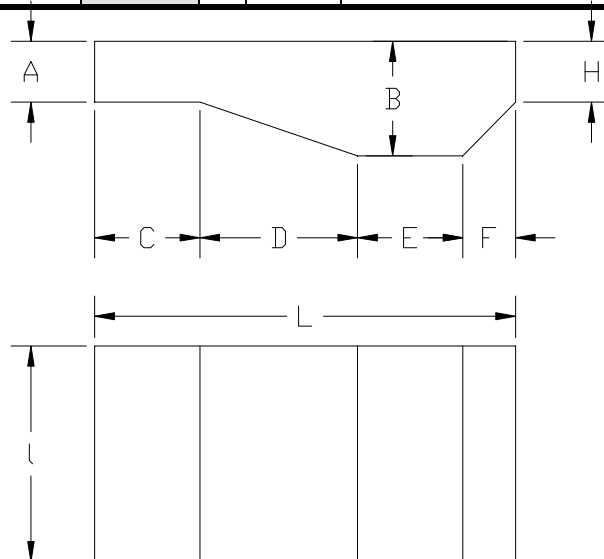

L	I	A	B	C	D	E	F	H

Verificar  $C + D + E + F = L$

# DAYAMON POOL

Liner

Pedido

Presupuesto

**EMISOR**

Fecha : .....

Ref. Cliente : .....

Cenefa	Azul	Verde	Ocre
Carthago	<input type="checkbox"/>	<input type="checkbox"/>	<input type="checkbox"/>
Pompeya	<input type="checkbox"/>	<input type="checkbox"/>	<input type="checkbox"/>
Mykonos	<input type="checkbox"/>	<input type="checkbox"/>	<input type="checkbox"/>
Olympia	<input type="checkbox"/>	<input type="checkbox"/>	<input type="checkbox"/>
Caribe	<input type="checkbox"/>	<input type="checkbox"/>	<input type="checkbox"/>
Alegro	<input type="checkbox"/>	<input type="checkbox"/>	<input type="checkbox"/>
Colonia	<input type="checkbox"/>	<input type="checkbox"/>	<input type="checkbox"/>
Navalon	<input type="checkbox"/>	<input type="checkbox"/>	<input type="checkbox"/>
Sebastian	<input type="checkbox"/>	<input type="checkbox"/>	<input type="checkbox"/>
Mosaico	<input type="checkbox"/>	<input type="checkbox"/>	<input type="checkbox"/>
Florentina	<input type="checkbox"/>	<input type="checkbox"/>	<input type="checkbox"/>
Benedicta	<input type="checkbox"/>	<input type="checkbox"/>	<input type="checkbox"/>
Rocas	<input type="checkbox"/>	<input type="checkbox"/>	<input type="checkbox"/>
Boreal	<input type="checkbox"/>	<input type="checkbox"/>	<input type="checkbox"/>

Muros Estampados	
Wyndham	<input type="checkbox"/>
Lexington Wall	<input type="checkbox"/>
Lankshire Wall	<input type="checkbox"/>
Caribe	<input type="checkbox"/>
Dacota	<input type="checkbox"/>

Colores Lisos	
Azul France	<input type="checkbox"/>
Azul Claro	<input type="checkbox"/>
Verde Caribe	<input type="checkbox"/>
Blanco	<input type="checkbox"/>
Arena	<input type="checkbox"/>
Negro	<input type="checkbox"/>
Gris	<input type="checkbox"/>

Colores Estampados	
Mosaico	<input type="checkbox"/>
Servana	<input type="checkbox"/>
Mármol Azul	<input type="checkbox"/>
Mármol Verde	<input type="checkbox"/>
Mármol Arena	<input type="checkbox"/>
Bizantino Azul	<input type="checkbox"/>
BizantinoVerde	<input type="checkbox"/>

<b>Perfil</b>	Hung	<input type="checkbox"/>	Otra	
<b>Espesor</b>	75/100	<input type="checkbox"/>	Otra	
<b>Radio Vert.</b>	15 cm	<input type="checkbox"/>	Otra	
<b>Radio Hori.</b>	5 cm	<input type="checkbox"/>	Otra	

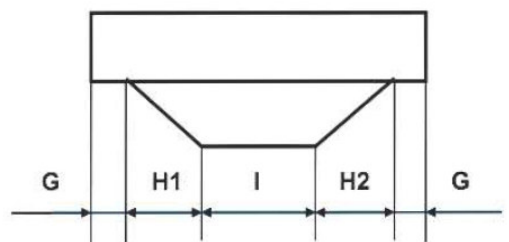
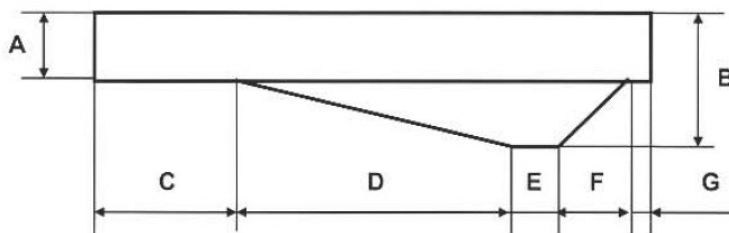
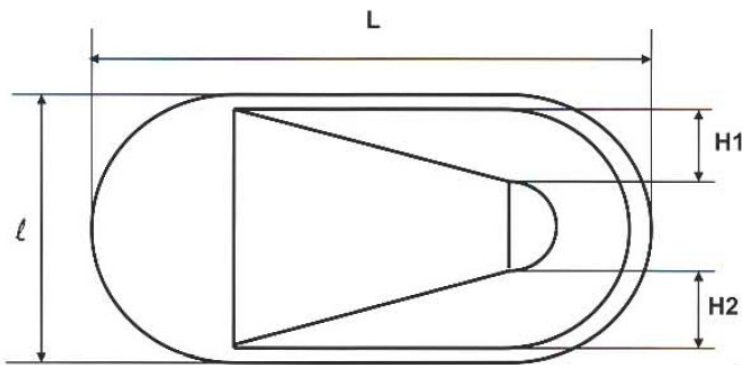

L	l	A	B

C	D	E	F	G

G	H1	I	H2	G

# DAYAMON POOL

Liner

Pedido

Presupuesto

**EMISOR**

Fecha : .....

Ref. Cliente : .....

Cenefa	Azul	Verde	Ocre
Carthago	<input type="checkbox"/>	<input type="checkbox"/>	<input type="checkbox"/>
Pompeya	<input type="checkbox"/>	<input type="checkbox"/>	<input type="checkbox"/>
Mykonos	<input type="checkbox"/>	<input type="checkbox"/>	<input type="checkbox"/>
Olympia	<input type="checkbox"/>	<input type="checkbox"/>	<input type="checkbox"/>
Caribe	<input type="checkbox"/>	<input type="checkbox"/>	<input type="checkbox"/>
Alegro	<input type="checkbox"/>	<input type="checkbox"/>	<input type="checkbox"/>
Colonia	<input type="checkbox"/>	<input type="checkbox"/>	<input type="checkbox"/>
Navalon	<input type="checkbox"/>	<input type="checkbox"/>	<input type="checkbox"/>
Sebastian	<input type="checkbox"/>	<input type="checkbox"/>	<input type="checkbox"/>
Mosaico	<input type="checkbox"/>	<input type="checkbox"/>	<input type="checkbox"/>
Florentina	<input type="checkbox"/>	<input type="checkbox"/>	<input type="checkbox"/>
Benedicta	<input type="checkbox"/>	<input type="checkbox"/>	<input type="checkbox"/>
Rocas	<input type="checkbox"/>	<input type="checkbox"/>	<input type="checkbox"/>
Boreal	<input type="checkbox"/>	<input type="checkbox"/>	<input type="checkbox"/>

Muros Estampados	
Wyndham	<input type="checkbox"/>
Lexington Wall	<input type="checkbox"/>
Lankshire Wall	<input type="checkbox"/>
Caribe	<input type="checkbox"/>
Dacota	<input type="checkbox"/>

Colores Lisos	
Azul France	<input type="checkbox"/>
Azul Claro	<input type="checkbox"/>
Verde Caribe	<input type="checkbox"/>
Blanco	<input type="checkbox"/>
Arena	<input type="checkbox"/>
Negro	<input type="checkbox"/>
Gris	<input type="checkbox"/>

Colores Estampados	
Mosaico	<input type="checkbox"/>
Servana	<input type="checkbox"/>
Mármol Azul	<input type="checkbox"/>
Mármol Verde	<input type="checkbox"/>
Mármol Arena	<input type="checkbox"/>
Bizantino Azul	<input type="checkbox"/>
BizantinoVerde	<input type="checkbox"/>

<b>Perfil</b>	Hung	<input type="checkbox"/>	Otra	
<b>Espesor</b>	75/100	<input type="checkbox"/>	Otra	
<b>Radio Vert.</b>	15 cm	<input type="checkbox"/>	Otra	
<b>Radio Hori.</b>	5 cm	<input type="checkbox"/>	Otra	

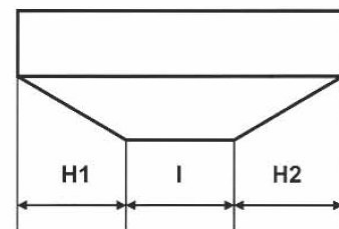
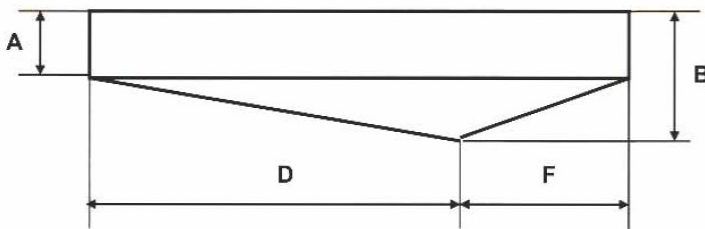
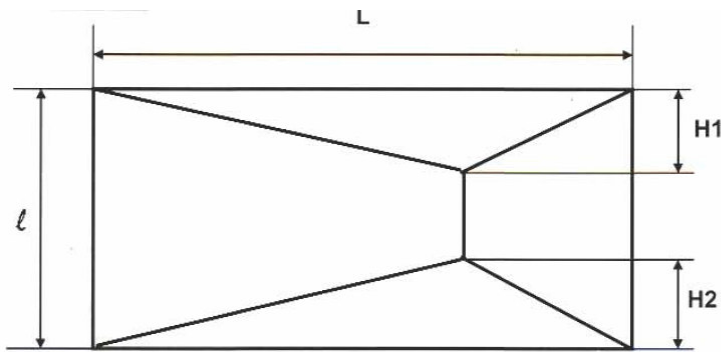

L	l	A	B

D	F

H1	I	H2



# DAYAMON POOL

Liner

Pedido

Presupuesto

**EMISOR**

Fecha : .....

Ref. Cliente : .....

Cenefa	Azul	Verde	Ocre
Carthago	<input type="checkbox"/>	<input type="checkbox"/>	<input type="checkbox"/>
Pompeya	<input type="checkbox"/>	<input type="checkbox"/>	<input type="checkbox"/>
Mykonos	<input type="checkbox"/>	<input type="checkbox"/>	<input type="checkbox"/>
Olympia	<input type="checkbox"/>	<input type="checkbox"/>	<input type="checkbox"/>
Caribe	<input type="checkbox"/>	<input type="checkbox"/>	<input type="checkbox"/>
Alegro	<input type="checkbox"/>	<input type="checkbox"/>	<input type="checkbox"/>
Colonia	<input type="checkbox"/>	<input type="checkbox"/>	<input type="checkbox"/>
Navalon	<input type="checkbox"/>	<input type="checkbox"/>	<input type="checkbox"/>
Sebastian	<input type="checkbox"/>	<input type="checkbox"/>	<input type="checkbox"/>
Mosaico	<input type="checkbox"/>	<input type="checkbox"/>	<input type="checkbox"/>
Florentina	<input type="checkbox"/>	<input type="checkbox"/>	<input type="checkbox"/>
Benedicta	<input type="checkbox"/>	<input type="checkbox"/>	<input type="checkbox"/>
Rocas	<input type="checkbox"/>	<input type="checkbox"/>	<input type="checkbox"/>
Boreal	<input type="checkbox"/>	<input type="checkbox"/>	<input type="checkbox"/>

Muros Estampados	
Wyndham	<input type="checkbox"/>
Lexington Wall	<input type="checkbox"/>
Lankshire Wall	<input type="checkbox"/>
Caribe	<input type="checkbox"/>
Dacota	<input type="checkbox"/>

Colores Lisos	
Azul France	<input type="checkbox"/>
Azul Claro	<input type="checkbox"/>
Verde Caribe	<input type="checkbox"/>
Blanco	<input type="checkbox"/>
Arena	<input type="checkbox"/>
Negro	<input type="checkbox"/>
Gris	<input type="checkbox"/>

Colores Estampados	
Mosaico	<input type="checkbox"/>
Servana	<input type="checkbox"/>
Mármol Azul	<input type="checkbox"/>
Mármol Verde	<input type="checkbox"/>
Mármol Arena	<input type="checkbox"/>
Bizantino Azul	<input type="checkbox"/>
BizantinoVerde	<input type="checkbox"/>

<b>Perfil</b>	Hung	<input type="checkbox"/>	Otra	
<b>Espesor</b>	75/100	<input type="checkbox"/>	Otra	
<b>Radio Vert.</b>	15 cm	<input type="checkbox"/>	Otra	
<b>Radio Hori.</b>	5 cm	<input type="checkbox"/>	Otra	

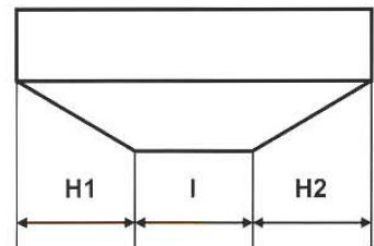
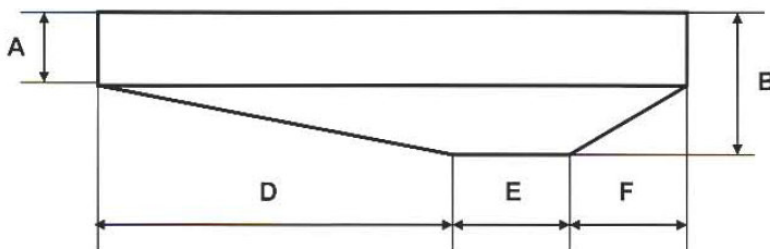
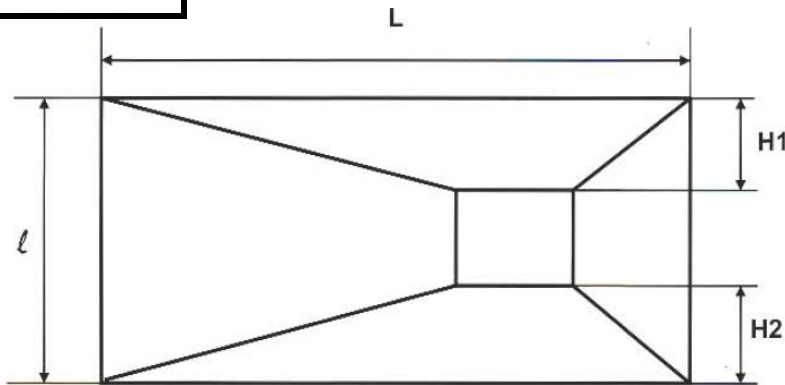

L	l	A	B

D	E	F

H1	I	H2

# DAYAMON POOL

Liner

Pedido

Presupuesto

**EMISOR**

Fecha : .....

Ref. Cliente : .....

Cenefa	Azul	Verde	Ocre
Carthago	<input type="checkbox"/>	<input type="checkbox"/>	<input type="checkbox"/>
Pompeya	<input type="checkbox"/>	<input type="checkbox"/>	<input type="checkbox"/>
Mykonos	<input type="checkbox"/>	<input type="checkbox"/>	<input type="checkbox"/>
Olympia	<input type="checkbox"/>	<input type="checkbox"/>	<input type="checkbox"/>
Caribe	<input type="checkbox"/>	<input type="checkbox"/>	<input type="checkbox"/>
Alegro	<input type="checkbox"/>	<input type="checkbox"/>	<input type="checkbox"/>
Colonia	<input type="checkbox"/>	<input type="checkbox"/>	<input type="checkbox"/>
Navalon	<input type="checkbox"/>	<input type="checkbox"/>	<input type="checkbox"/>
Sebastian	<input type="checkbox"/>	<input type="checkbox"/>	<input type="checkbox"/>
Mosaico	<input type="checkbox"/>	<input type="checkbox"/>	<input type="checkbox"/>
Florentina	<input type="checkbox"/>	<input type="checkbox"/>	<input type="checkbox"/>
Benedicta	<input type="checkbox"/>	<input type="checkbox"/>	<input type="checkbox"/>
Rocas	<input type="checkbox"/>	<input type="checkbox"/>	<input type="checkbox"/>
Boreal	<input type="checkbox"/>	<input type="checkbox"/>	<input type="checkbox"/>

Muros Estampados	
Wyndham	<input type="checkbox"/>
Lexington Wall	<input type="checkbox"/>
Lankshire Wall	<input type="checkbox"/>
Caribe	<input type="checkbox"/>
Dacota	<input type="checkbox"/>

Colores Lisos	
Azul France	<input type="checkbox"/>
Azul Claro	<input type="checkbox"/>
Verde Caribe	<input type="checkbox"/>
Blanco	<input type="checkbox"/>
Arena	<input type="checkbox"/>
Negro	<input type="checkbox"/>
Gris	<input type="checkbox"/>

Colores Estampados	
Mosaico	<input type="checkbox"/>
Servana	<input type="checkbox"/>
Mármol Azul	<input type="checkbox"/>
Mármol Verde	<input type="checkbox"/>
Mármol Arena	<input type="checkbox"/>
Bizantino Azul	<input type="checkbox"/>
BizantinoVerde	<input type="checkbox"/>

<b>Perfil</b>	Hung	<input type="checkbox"/>	Otra	
<b>Espesor</b>	75/100	<input type="checkbox"/>	Otra	
<b>Radio Vert.</b>	15 cm	<input type="checkbox"/>	Otra	
<b>Radio Hori.</b>	5 cm	<input type="checkbox"/>	Otra	

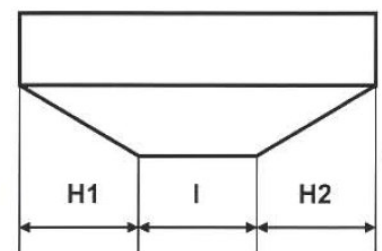
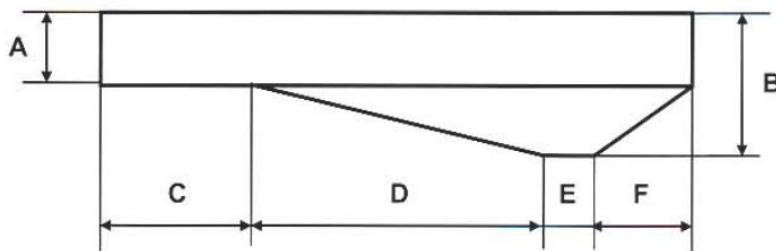
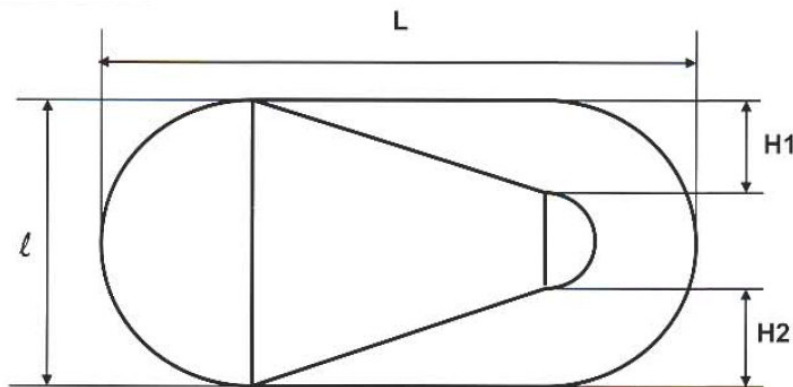

L	l	A	B

C	D	E	F

H1	I	H2

# DAYAMON POOL

Liner

Pedido

Presupuesto

**EMISOR**

Fecha : .....

Ref. Cliente : .....

Cenefa	Azul	Verde	Ocre
Carthago	<input type="checkbox"/>	<input type="checkbox"/>	<input type="checkbox"/>
Pompeya	<input type="checkbox"/>	<input type="checkbox"/>	<input type="checkbox"/>
Mykonos	<input type="checkbox"/>	<input type="checkbox"/>	<input type="checkbox"/>
Olympia	<input type="checkbox"/>	<input type="checkbox"/>	<input type="checkbox"/>
Caribe	<input type="checkbox"/>	<input type="checkbox"/>	<input type="checkbox"/>
Alegro	<input type="checkbox"/>	<input type="checkbox"/>	<input type="checkbox"/>
Colonia	<input type="checkbox"/>	<input type="checkbox"/>	<input type="checkbox"/>
Navalon	<input type="checkbox"/>	<input type="checkbox"/>	<input type="checkbox"/>
Sebastian	<input type="checkbox"/>	<input type="checkbox"/>	<input type="checkbox"/>
Mosaico	<input type="checkbox"/>	<input type="checkbox"/>	<input type="checkbox"/>
Florentina	<input type="checkbox"/>	<input type="checkbox"/>	<input type="checkbox"/>
Benedicta	<input type="checkbox"/>	<input type="checkbox"/>	<input type="checkbox"/>
Rocas	<input type="checkbox"/>	<input type="checkbox"/>	<input type="checkbox"/>
Boreal	<input type="checkbox"/>	<input type="checkbox"/>	<input type="checkbox"/>

Muros Estampados	
Wyndham	<input type="checkbox"/>
Lexington Wall	<input type="checkbox"/>
Lankshire Wall	<input type="checkbox"/>
Caribe	<input type="checkbox"/>
Dacota	<input type="checkbox"/>

Colores Lisos	
Azul France	<input type="checkbox"/>
Azul Claro	<input type="checkbox"/>
Verde Caribe	<input type="checkbox"/>
Blanco	<input type="checkbox"/>
Arena	<input type="checkbox"/>
Negro	<input type="checkbox"/>
Gris	<input type="checkbox"/>

Colores Estampados	
Mosaico	<input type="checkbox"/>
Servana	<input type="checkbox"/>
Mármol Azul	<input type="checkbox"/>
Mármol Verde	<input type="checkbox"/>
Mármol Arena	<input type="checkbox"/>
Bizantino Azul	<input type="checkbox"/>
BizantinoVerde	<input type="checkbox"/>

<b>Perfil</b>	Hung	<input type="checkbox"/>	Otra	
<b>Espesor</b>	75/100	<input type="checkbox"/>	Otra	
<b>Radio Vert.</b>	15 cm	<input type="checkbox"/>	Otra	
<b>Radio Hori.</b>	5 cm	<input type="checkbox"/>	Otra	

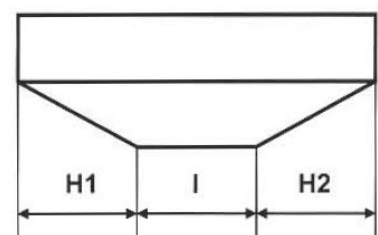
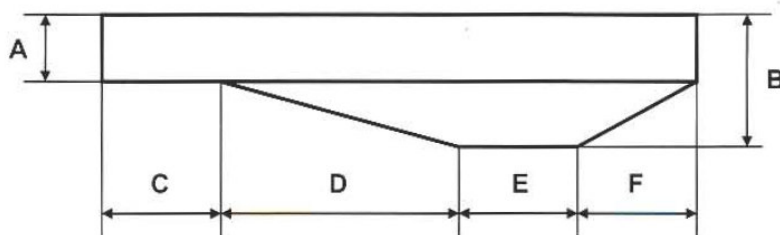
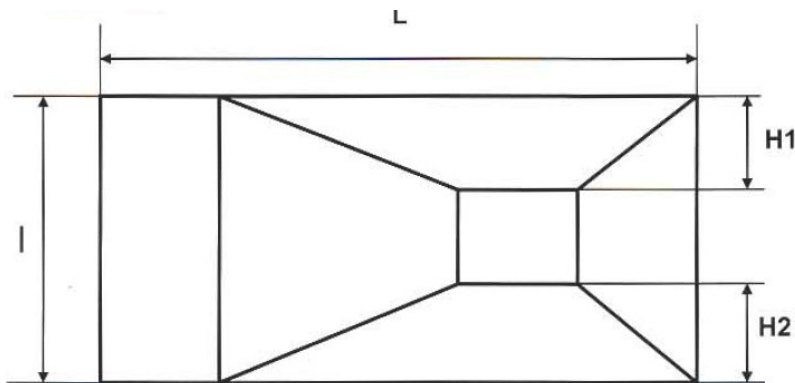

L	l	A	B

C	D	E	F

H1	I	H2

# DAYAMON POOL

Liner

Pedido

Presupuesto

**EMISOR**

Fecha : .....

Ref. Cliente : .....

Cenefa	Azul	Verde	Ocre
Carthago	<input type="checkbox"/>	<input type="checkbox"/>	<input type="checkbox"/>
Pompeya	<input type="checkbox"/>	<input type="checkbox"/>	<input type="checkbox"/>
Mykonos	<input type="checkbox"/>	<input type="checkbox"/>	<input type="checkbox"/>
Olympia	<input type="checkbox"/>	<input type="checkbox"/>	<input type="checkbox"/>
Caribe	<input type="checkbox"/>	<input type="checkbox"/>	<input type="checkbox"/>
Alegro	<input type="checkbox"/>	<input type="checkbox"/>	<input type="checkbox"/>
Colonia	<input type="checkbox"/>	<input type="checkbox"/>	<input type="checkbox"/>
Navalon	<input type="checkbox"/>	<input type="checkbox"/>	<input type="checkbox"/>
Sebastian	<input type="checkbox"/>	<input type="checkbox"/>	<input type="checkbox"/>
Mosaico	<input type="checkbox"/>	<input type="checkbox"/>	<input type="checkbox"/>
Florentina	<input type="checkbox"/>	<input type="checkbox"/>	<input type="checkbox"/>
Benedicta	<input type="checkbox"/>	<input type="checkbox"/>	<input type="checkbox"/>
Rocas	<input type="checkbox"/>	<input type="checkbox"/>	<input type="checkbox"/>
Boreal	<input type="checkbox"/>	<input type="checkbox"/>	<input type="checkbox"/>

Muros Estampados	
Wyndham	<input type="checkbox"/>
Lexington Wall	<input type="checkbox"/>
Lankshire Wall	<input type="checkbox"/>
Caribe	<input type="checkbox"/>
Dacota	<input type="checkbox"/>

Colores Lisos	
Azul France	<input type="checkbox"/>
Azul Claro	<input type="checkbox"/>
Verde Caribe	<input type="checkbox"/>
Blanco	<input type="checkbox"/>
Arena	<input type="checkbox"/>
Negro	<input type="checkbox"/>
Gris	<input type="checkbox"/>

Colores Estampados	
Mosaico	<input type="checkbox"/>
Servana	<input type="checkbox"/>
Mármol Azul	<input type="checkbox"/>
Mármol Verde	<input type="checkbox"/>
Mármol Arena	<input type="checkbox"/>
Bizantino Azul	<input type="checkbox"/>
Bizantino Verde	<input type="checkbox"/>

<b>Perfil</b>	Hung	<input type="checkbox"/>	Otra	
<b>Espesor</b>	75/100	<input type="checkbox"/>	Otra	
<b>Radio Vert.</b>	15 cm	<input type="checkbox"/>	Otra	
<b>Radio Hori.</b>	5 cm	<input type="checkbox"/>	Otra	

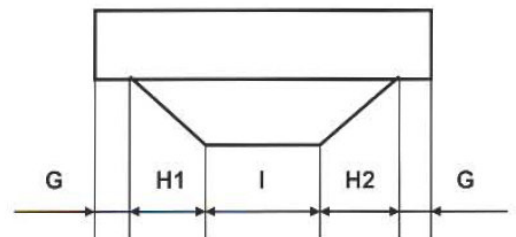
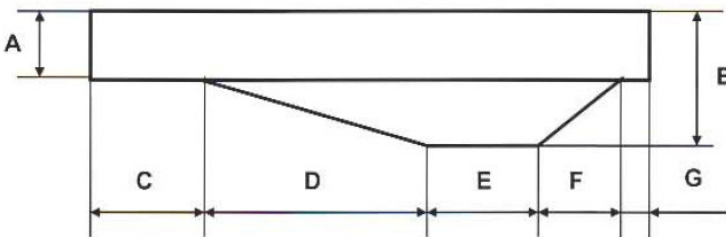
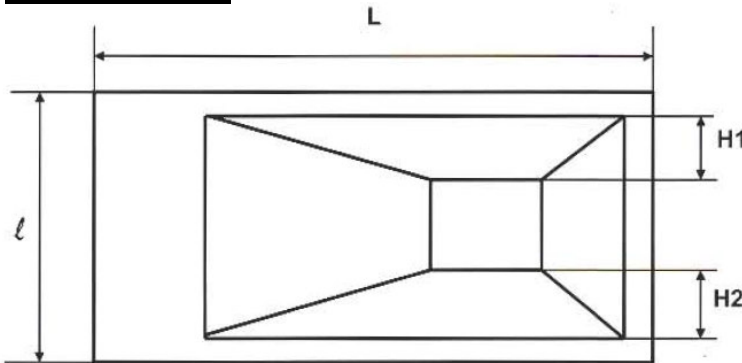

L	$\ell$	A	B

C	D	E	F	G

G	H1	I	H2	G